

JB-DK100/10-ALW-AW75
JB-DK135-150/10-ALW-AW125

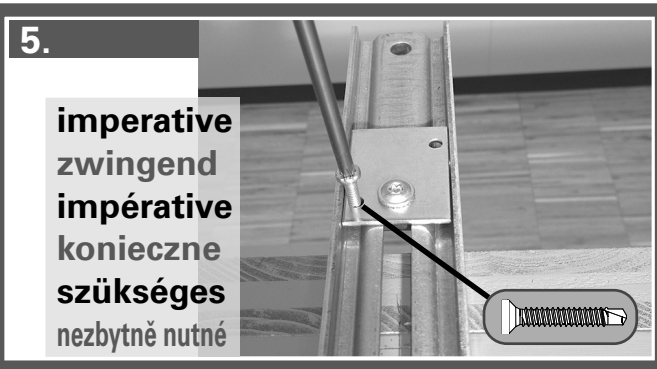
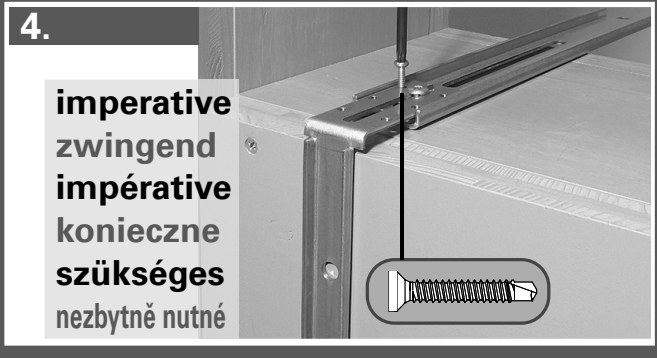
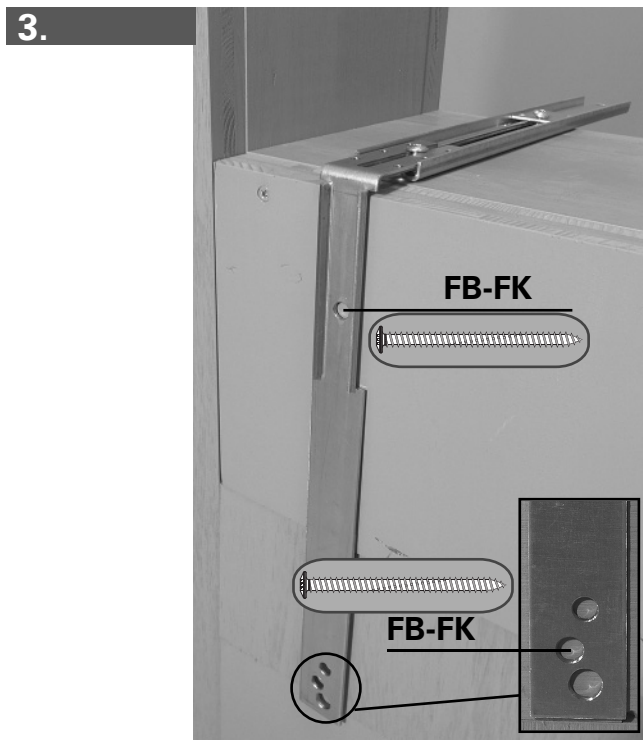
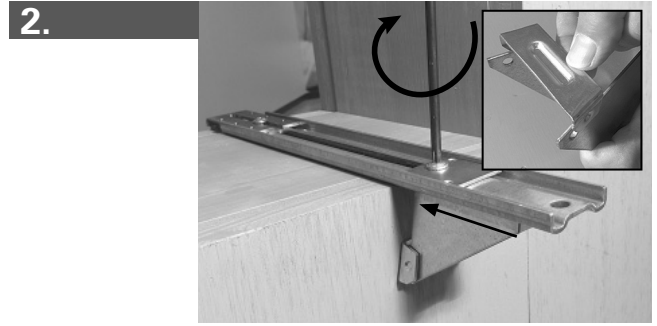
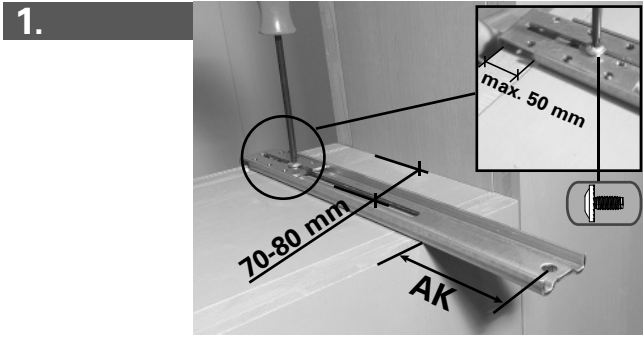
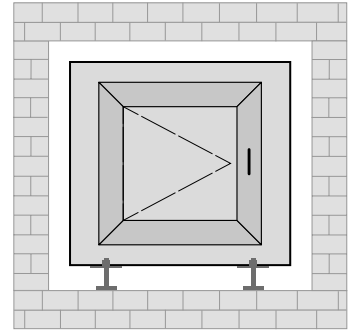
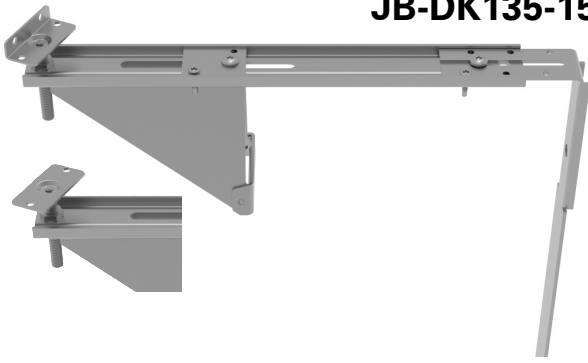

Vor der Ausführung sind sämtliche Berechnungen vom verantwortlichen Planer zu überprüfen und freizugeben. Der Anwender ist für die Einhaltung von evtl. lokalen oder nationalen gesetzlichen Vorschriften verantwortlich.

© SFS intec, 2016
 Mat. Nr. 1486692
 MA_JB-DK_Standard_100-150-200_ALW_AW_HLZ_2016-02-17
 Technische Änderungen vorbehalten
 Gedruckt in der Schweiz